

ORTHOPANTOMOGRAPH® OP300

A platform for changing needs.



INSTRUMENTARIUM



“For me, **peace of mind** means a patient trusting in my care, time after time”

Leading the way through the decades.

- 1946 Professor Y.V. Paatero publishes his first paper on Panoramic Tomography.
- 1951 “Pantomography” equipment is presented.
- 1961 The first dental panoramic X-ray, ORTHOPANTOMOGRAPH® OP1, is developed.
- 1964 Commercialization of the ORTHOPANTOMOGRAPH® units begins with models OP2 and OP3.
- 1978 ORTHOPANTOMOGRAPH® system becomes the leading name within dental panoramic imaging with models OP5/OC5, OP6 and OP10/OC10.
- 1992 New innovations, such as the lifting cassette head and linear tomography, are introduced along with the OP100 product family.
- 1999 Direct digital ORTHOPANTOMOGRAPH® OP100 product family is introduced.
- 2006 New ORTHOPANTOMOGRAPH® product family OP200 is launched.
- 2007 Volumetric Tomography (VT) is developed to maximize the performance of an ORTHOPANTOMOGRAPH® unit.
- 2009 A new member to the ORTHOPANTOMOGRAPH® product family – OP30 – is launched.
- 2011 CBCT era begins. ORTHOPANTOMOGRAPH® OP300, the most comprehensive 3-in-1 platform is launched to celebrate 50 years of ORTHOPANTOMOGRAPH® success.
- 2013 Introduction of improved 3D image quality, new metal artifact reduction (MAR) tool and endo mode for ORTHOPANTOMOGRAPH® OP300 3D images.
- 2013 New revision of ORTHOPANTOMOGRAPH® OP30 unit is launched.
- 2014 ORTHOPANTOMOGRAPH® OP300 Maxio configuration, offering diagnostic information of the entire maxillofacial region, is launched.

For more than 50 years, the name of ORTHOPANTOMOGRAPH® system has stood for the ultimate reliability and clinically correct maxillofacial imaging.

ORTHOPANTOMOGRAPH® OP300 is the most comprehensive 3-in-1 platform designed for today and tomorrow. OP300 combines an advanced panoramic imaging system with either cephalometric or cone beam 3D or a combination of both, giving you a truly adaptable platform for imaging applications. ORTHOPANTOMOGRAPH® OP300 platform masters the details.



The Genuine One.

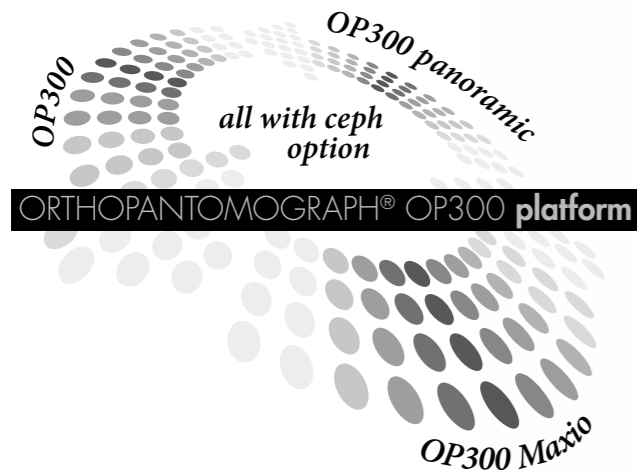

The Core.

Gold standard image quality

Decades of experience along with gold standard image quality are combined in the ORTHOPANTOMOGRAPH® OP300, for your benefit.

Efficient clinical use

With the OP300 platform, imaging is straightforward. Patient positioning is intuitive and precise. Image settings are smoothly set with an easy-to-use user interface. Versatile imaging software enables efficient diagnosis. As a result, workflow is fast and effortless.

Excellence for all clinical needs.

*General practitioners – Endodontics – Implantology
– Orthodontics – Maxillofacial surgery – ENT*



OP300 panoramic – Perfection brings confidence

Consistent, repeatable gold standard image quality offers power to diagnose quickly and efficiently. A full range of panoramic imaging programs cover multiple modalities from everyday procedures to even more specialized imaging procedures. The unique combination of dedicated panoramic sensor, ADC, easy patient positioning and the best possible imaging geometry provide excellent diagnostic images – time after time.

Automatic Dose Control (ADC)

Proprietary ADC technology automatically optimizes panoramic exposure levels for each patient and during every acquisition, resulting in patient-specific dosage. This also enhances workflow efficiency.

Multilayer pan

The OP300 multilayer feature provides five panoramic images with only one scan. This enables forgiving patient positioning and difficult anatomies, reducing the risk of retake exposures. Multilayer images are achieved in the same scanning time and dose as the traditional panoramic scan.

Accurate and stable patient positioning

Correct positioning is assured by automatically operated three positioning laser lights. A rigid 5-point positioning system eliminates patient movement. The open product design allows easy viewing and positioning of the patient.



Complete versatility

ORTHOPANTOMOGRAPH® OP300 is a platform for changing needs. OP300 Panoramic can be upgraded with CBCT or cephalometric modalities.



OP300 CBCT

– Control without compromise

With ORTHOPANTOMOGRAPH® units, no compromises have been made as to usability. The OP300 CBCT systems offer ultimate control for obtaining diagnostic information from the correct region of interest. This is achieved with the optimum combination of patient positioning, SMARTVIEW™ scout image and volume positioning.

User-experience in focus

The large, easy-to-use 10" user interface enables intuitive usage and setting of imaging parameters from the very beginning. The result is fast and effortless workflow for all modalities.

Precise positioning

Precise positioning starts from accurate patient positioning of the OP300. To reduce the need for retake exposures, a two-dimensional scout image, SMARTVIEW™ can be taken before the CBCT examination. From the scout image, the position of the volume can be verified or corrected if needed. Unit positioning is automatic.

Free field-of-view positioning

With the OP300, there is no need to compromise with FOV positioning. The FOV location can be positioned freely in both horizontal and vertical directions, with ease and confidence.

Even the smallest FOV can be efficiently and precisely positioned with the help of the intuitive user interface, SMARTVIEW™ functionality and free positioning of FOV.



Complete versatility

ORTHOPANTOMOGRAPH® OP300 is a platform for changing needs. Both OP300 and OP300 Maxio can be upgraded with cephalometric modality.

Even the smallest FOV can be positioned precisely, for example to the TMJ.





OP300 CBCT – Confidence builds on knowledge

With ORTHOPANTOMOGRAPH® units, no compromises have been made in any aspects of image quality. Imaging values are optimized for each imaging program. Both the volume and the resolution can be selected according to the indication and region of interest. Treatment plans can be made with confidence knowing that OP300 masters the details.

MAR tool

For the implant cases, endodontic analysis or any other case where metallic artifacts can be expected, CBCT images can be taken utilizing metal artifact reduction (MAR).

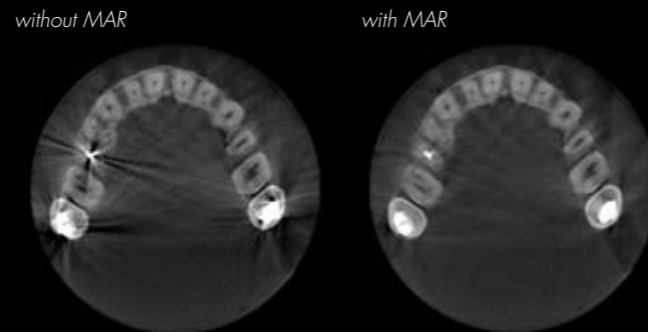

Resolution for each indication

For each FOV size, it is possible to choose between different resolutions.

Low Dose Technology™ (LDT) scan

can be utilized in dose sensitive cases and control or follow-up situations where lower resolution is acceptable

Standard resolution scan

with optimized patient dose can be used for general diagnostics

High resolution scan

offers extremely sharp images for more detailed diagnosis

Endo resolution scan

85 µm voxel size with MAR tool specially designed for endodontic applications. Endo resolution is available for the smallest FOV.



OP300

FOV 6x4 cm

Optimized for single site implants or localized diagnostics, keeping the patient dose at a substantially reduced level.

FOV 6x8 cm

Covers the complete dental arch for multiple implant placement and allows for the use of surgical guides.

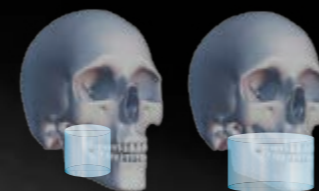

OP300 Maxio

FOV 5x5 cm

Optimized for single site implants or localized diagnostics, keeping the patient dose at a substantially reduced level.

FOV 6x8 cm

Covers the complete dental arch for multiple implant placement and allows for the use of surgical guides.

FOV 8x8 cm

Covers the entire dentition, including both mandibula and maxilla as well a portion of maxillary sinus.

FOV 8x15 cm

Covers both mandibula and maxilla including airway and upper cervical spine or the sinus. Both TM joints can also be studied.

FOV 13x15 cm (optional)

Covers the entire maxillofacial region.

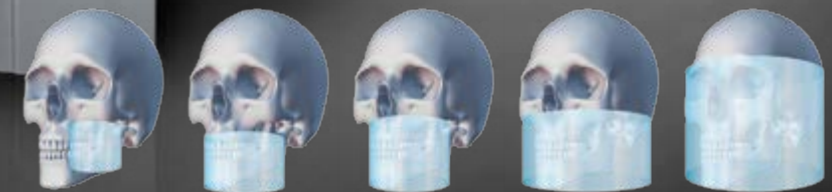

OP300 Maxio FOV 13x15 cm

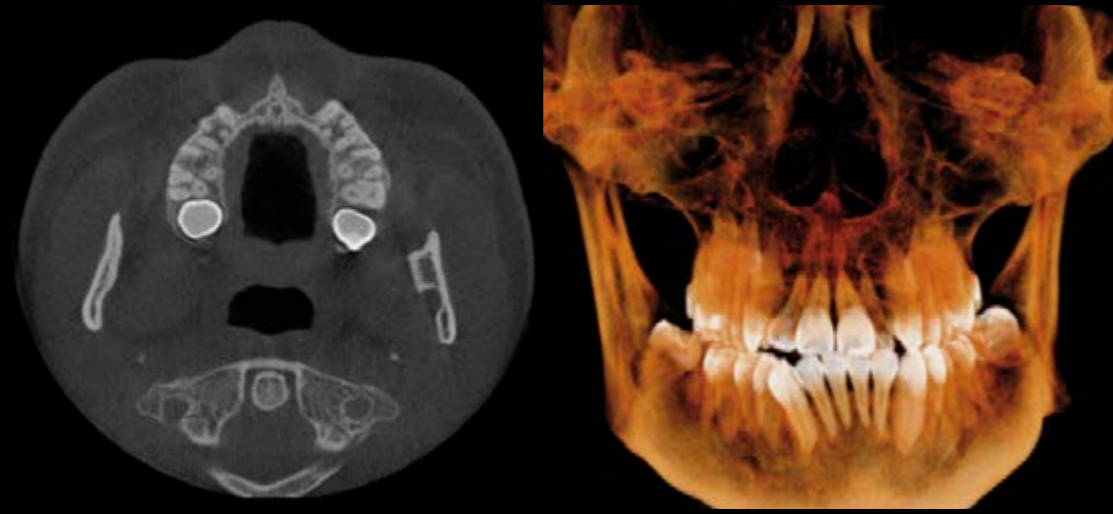
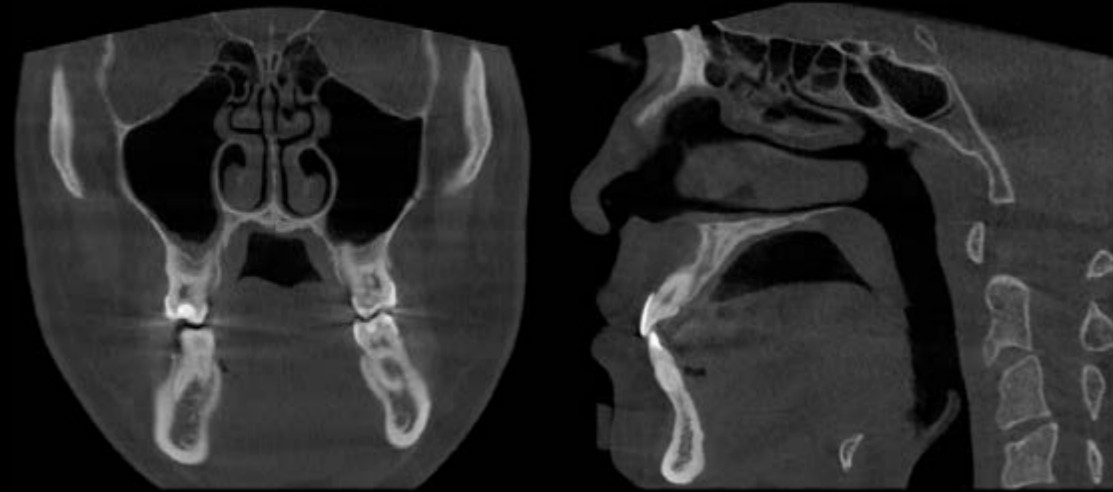

OP300 Maxio FOV 8x15 cm

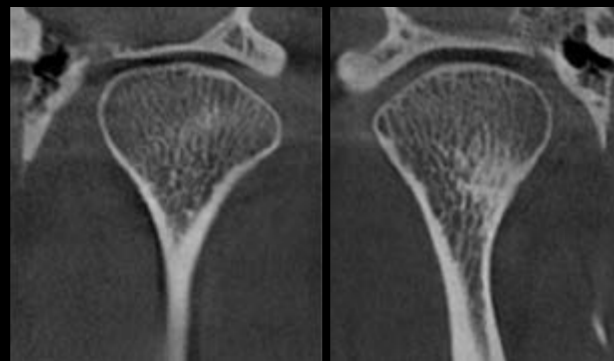
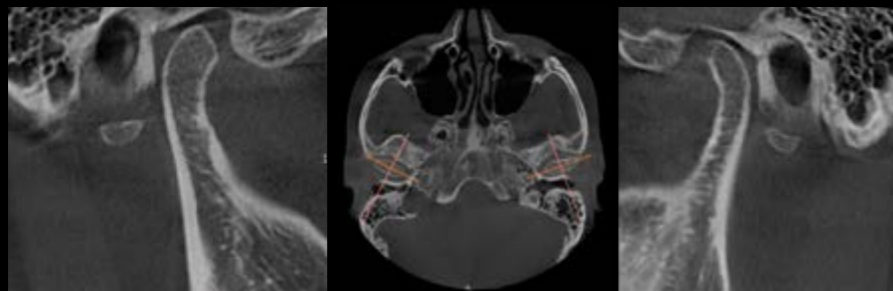

OP300 Maxio FOV 8x8 cm

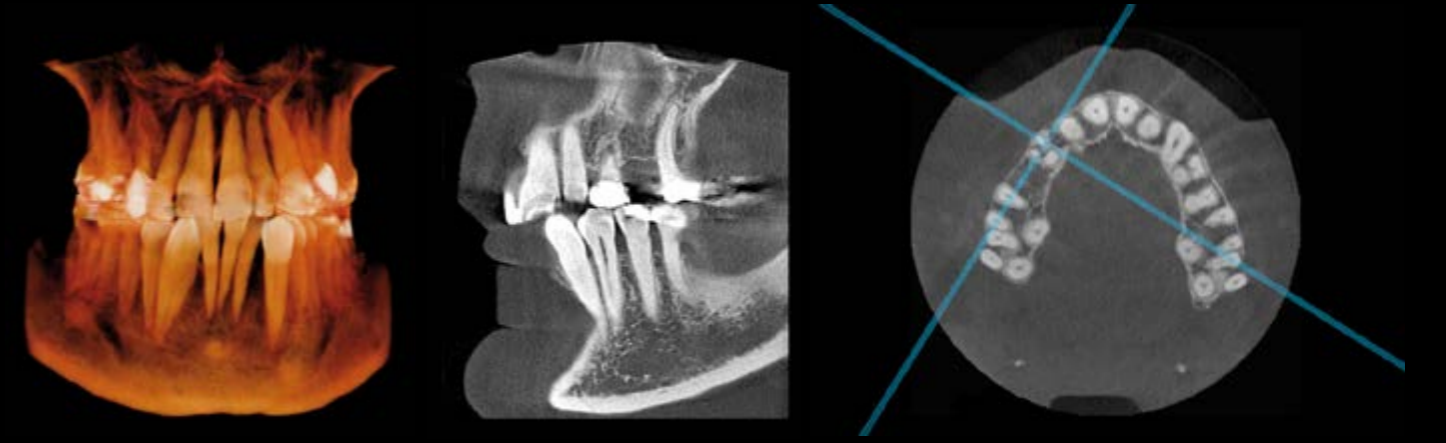

OP300 Maxio and OP300 FOV 6x8 cm

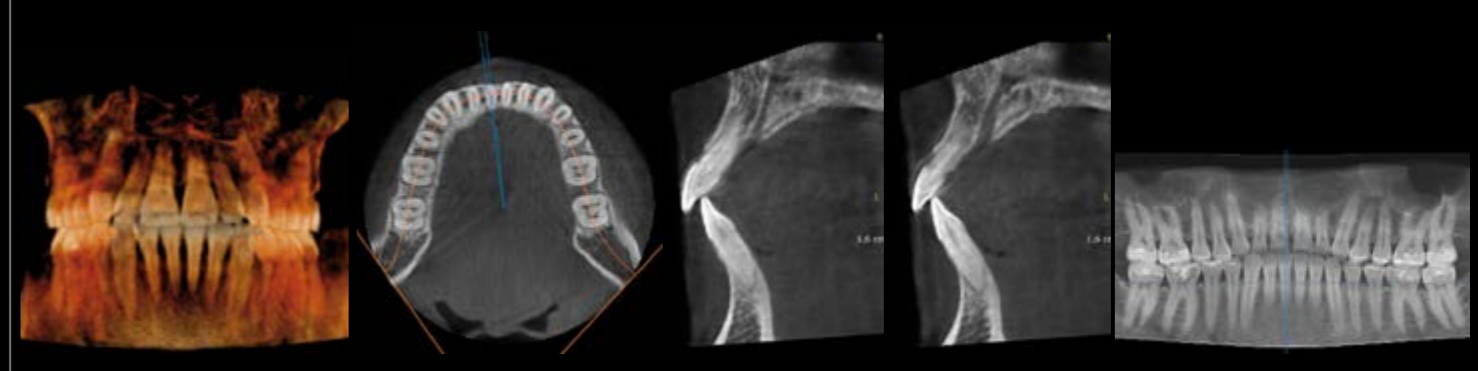

OP300 Maxio FOV 5x5 cm

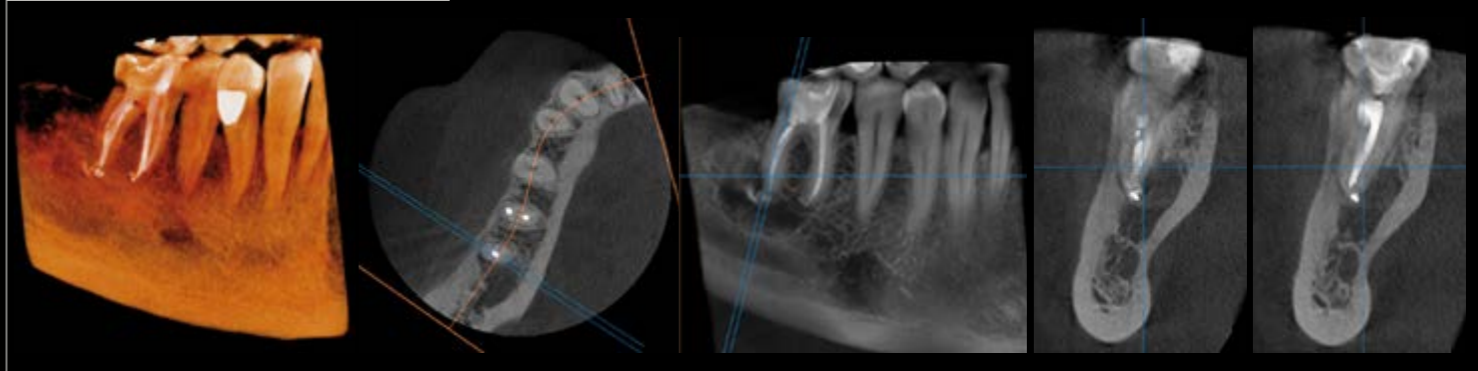

OP300 FOV 6x4 cm

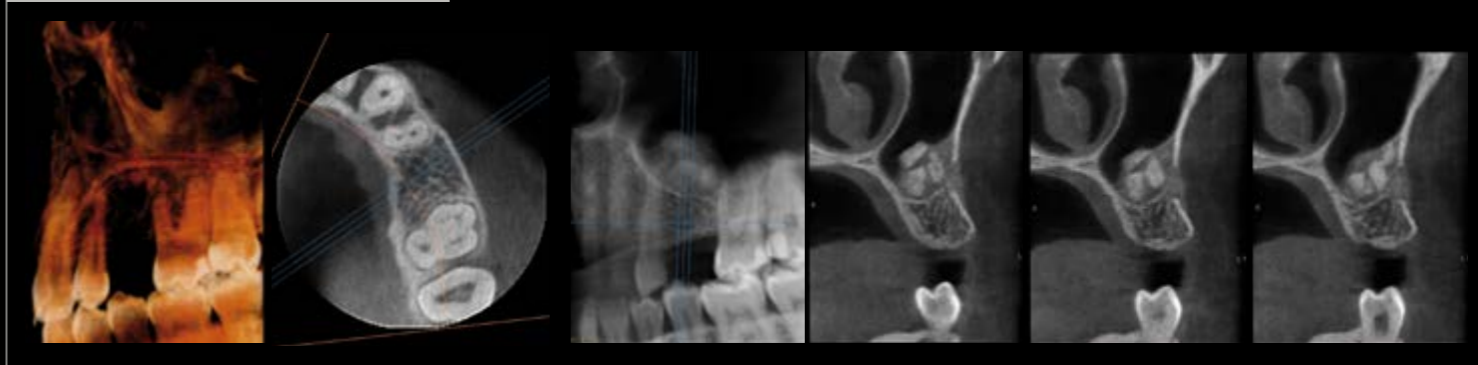

OP300 cephalometric – Unsurpassed results

A variety of cephalometric imaging programs are available for ORTHOPANTOMOGRAPH® OP300. The fully adjustable scanning area ensures that only the required region can be exposed, therefore decreasing the patient dose.

Excellent image quality for every patient

Automatic Facial Contour (AFC) automatically decreases the exposure values during the scan for better soft tissue definition in the facial region.

Accurate and stable patient positioning

The Frankfort horizontal laser light, nasion support and rigid ear rods make patient positioning easy and intuitive.

Complete versatility

The OP300 can truly grow with your practice and be tailored to your preferences. The cephalometric arm can be positioned either side for optimum use of space and user-experience.

True
3-in-1 platform

We care for your patients' well-being

As the original inventor of the ORTHOPANTOMOGRAPH® products, we have always strived to give our customers the very best tools to succeed. The ORTHOPANTOMOGRAPH® heritage of patient care builds on sectional panoramics, Automatic Exposure Control (AEC), Automatic Spine Compensation (ASC), Automatic Facial Contour (AFC) and adjustable scanning area on cephalometric imaging. The OP300, continues the legacy while introducing new innovations to take patient care even further.

OP300 Panoramic utilizes Automatic Dose Control (ADC) and ASC to obtain patient-specific correct imaging values, exposure after exposure and with any size of patient.

OP300 cephalometric users have the possibility to adjust the scanning area exposing only required area. In addition, dose is automatically decreased in the facial region with AFC.

OP300 CBCT users greatly benefit from versatile selection of different volumes and available resolutions, as well as precise and free volume positioning.

Image quality and patient dose optimized – in all OP300 programs.



Cephalometric



Cephalometric PA

Carpus imaging

Low Dose Technology™ with OP300 Maxio

OP300 Maxio users have the luxury of using Low Dose Technology™ (LDT), which provides quality optimized low dose scans while keeping the clinical value still intact. LDT is ideal for sensitive cases such as children, follow-up, even implant planning or any other case where lower resolution is acceptable.



CLINIVIEW™

OnDemand3D™ Dental

Fast and accurate diagnosis

The CLINIVIEW™ software is specifically designed for your workflow. Image storage and processing, as well as diagnostic decisions, treatment planning and printing, are built to function intuitively. The main focus is on extreme fluency of use for fast, accurate diagnoses.

CLINIVIEW™ software is highly compatible and connected. Utilizing the industry-standard DICOM format, images can be transported between CLINIVIEW™ software and a wide range of other sources, including TWAIN.

The perfect tool for 3D image viewing

OnDemand3D™ Dental is modular 3D software, allowing it to grow together with the user's needs. The new dental module has now five different logical views for daily work and, combined with the powerful database manager and the state-of-the-art reporting module, this software offers tools for efficient high quality diagnostics and treatment planning. A fusion module for stitching and superimposing images, and the In2Guide™ implant planning module for guided surgery needs, are available for those who want to extend the feature even further.



The perfect orthodontic tool

Optional **CLINIVIEW™ OrthoTrace** is a flexible and user-friendly tracing software for orthodontists and maxillofacial surgeons. Placing of landmarks is quick and accurate with intuitive software tools. Many ready-made cephalometric analyses enable effortless workflow from the beginning. Integration to CLINIVIEW™ is seamless.

*Orthodontic tracing – Cephalometric analysis
Superimposition – Treatment planning
– Soft tissue prediction*

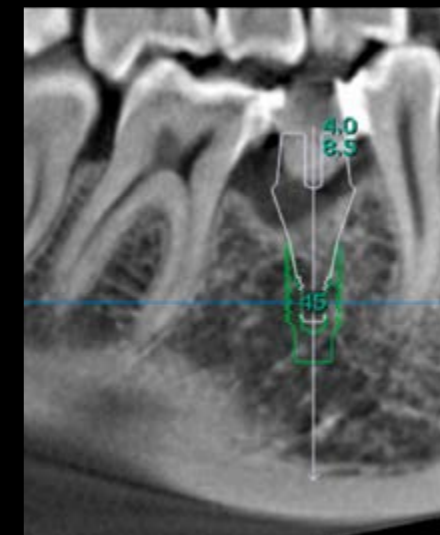
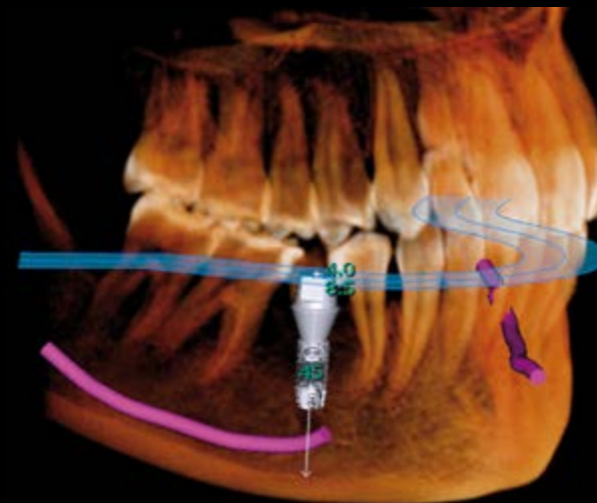
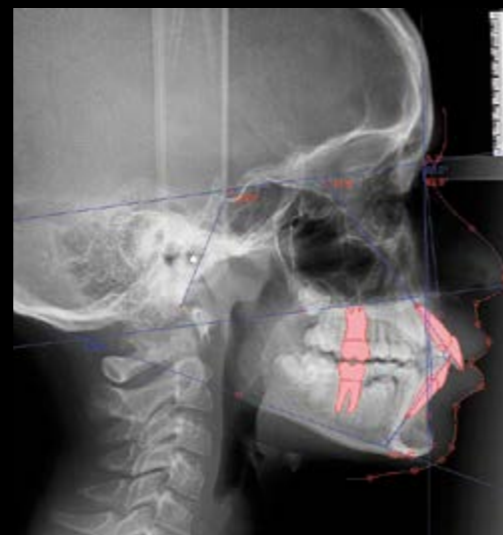

Dimensions

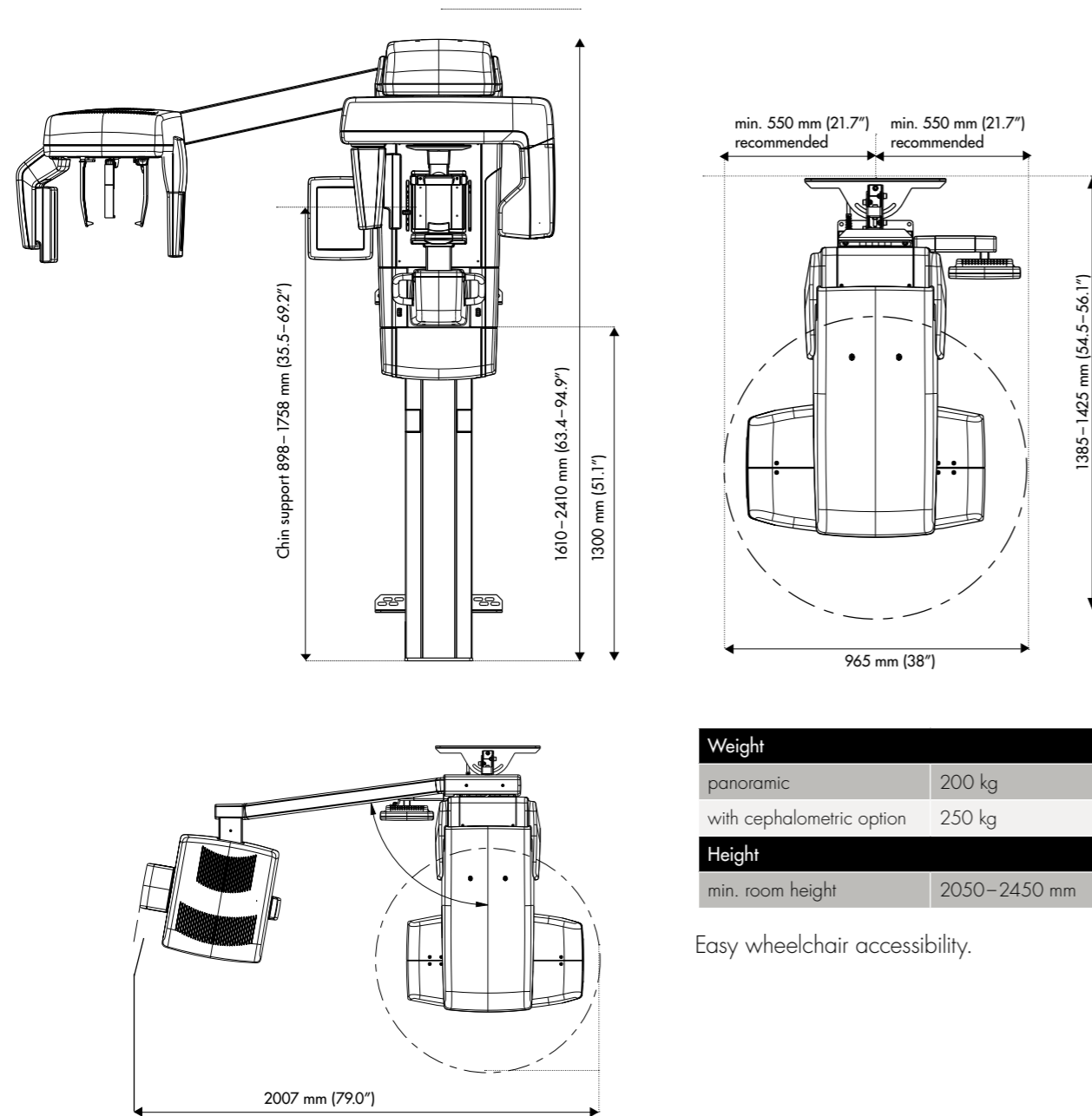

Weight	
panoramic	200 kg
with cephalometric option	250 kg
Height	
min. room height	2050 - 2450 mm

Easy wheelchair accessibility.

Technical specifications

Technical specifications			
generator	high frequency DC, 75-150 kHz		
focal spot	0.5 mm IEC 336		
tube voltage	57-90 kV		
tube current	3.2-16 mA		
HU capacity	35 kJ, 49 000 HU		
minimum total filtration	3.2 mm Al		
Panoramic		Cephalometric	
image detector	CMOS	image detector	CMOS
sensor pixel size	100 µm	sensor pixel size	100 µm
image pixel size	100 µm	image pixel size	100 µm
scan time	8.6-16.1 s	scan time	6.5 s - 20 s
image field height	151 mm	image field width	160 mm - 270 mm
imaging programs	standard, pediatric, ortho zone, orthogonal, wide arch, Lat TMJ, PA TMJ, Maxillary sinus, bitewing		
3D		OP300 Maxio	
image detector	CMOS	CMOS	
image voxel size	85 µm - 300 µm	85 µm - 420 µm	
scan time	10 - 20 s	10 - 40 s	
exposure time	2.34 - 12.5 s, pulsed X-ray	1.2 - 9 s, pulsed X-ray	
image volume sizes (HxW)	61x41, 61x78 mm	50x50, 61x78, 78x78, 78x150, 130x150 mm	
DICOM support	yes	yes	
Minimum system requirements for acquisition computer			
processor	2.5 GHz dual core, or better		
memory	8 GB RAM or more		
hard disk	500 GB or more		
expansion slot	PCI Express x16, full length		
network	Gigabit Ethernet, 1000Base-T		
power supply	500 watt minimum		
operating system	Windows 7, Windows Vista or Windows 8 (64-bit)		
Please refer to CLINIVIEW™ Installation manual for full software specifications and requirements or contact your local dealer.			

Choose your own ORTHOPANTOMOGRAPH®	OP30	OP200	OP300	OP300 Maxio
Standard panoramic	•			
Advanced panoramic		•	•	•
TMJ imaging	•	•	•	•
Cone Beam 3D			•	•
Cephalometric		•	•	•

Instrumentarium Dental develops, manufactures and markets high-tech systems and solutions for dental and maxillo-facial imaging. We work in close co-operation with dental professionals, universities and other research centers in our quest to develop solutions that will meet and exceed the expectations of our customers. As the establisher of panoramic X-ray imaging, we are committed to providing high clinical performance while still maintaining simplicity, ease of use and workflow efficiency. The Instrumentarium Dental product portfolio consists of a full range of premium quality imaging solutions for intraoral, extraoral and 3D imaging. For more detailed information about our products, please visit www.instrumentariumdental.com.

Instrumentarium Dental reserves the right to make changes to specifications and features shown herein, or to discontinue the product described at any time without notice or obligation. Contact your Instrumentarium Dental representative for the most current information. CE marked according to Medical Device Directive (NB 0537). Electrical safety according to IEC 60601-1. Operations comply with ISO 13485:2003, ISO 9001:2008, and ISO 14001:2004.

ORTHOPANTOMOGRAPH® / SMARTVIEW™ / CLINIVIEW™ / Low Dose Technology™ is a registered trademark/ a common law trademark of Instrumentarium Dental, PaloDEX Group Oy.



Headquarters

Instrumentarium Dental
Nahkelantie 160
P.O. Box 20
FI-04300 Tuusula
Finland
Tel. +358 10 270 2000
Fax +358 10 270 2230

USA

Instrumentarium Dental Inc.
1245 W. Canal Street
Milwaukee, Wisconsin 53233
U.S.A
Tel. +1 800 558 6120
Fax +1 414 481 8665

www.instrumentariumdental.com

© 2015 Instrumentarium Dental
207131-5 English